

The Facility Manager's Guide to Data Logging

Whole-Building Power Monitoring	2
Equipment Monitoring – HVAC	4
Some HVAC data analysis applications	4
Equipment Monitoring – Plug Loads	6
Lighting Systems Monitoring	8
Environmental Monitoring	10
Building Envelope Monitoring	12
Quantify Energy Savings	14
Quantify Savings Based on Runtime Hours	14
Quantify Savings Based on Monitoring Current	15
Quantify Savings Based on Monitoring Power	16
Data Logging Best Practices	18
General Best Practices	18
Power Monitoring Best Practices	19
HVAC Monitoring Best Practices	20
Plug Load Monitoring Best Practices	21
Lighting Monitoring Best Practices	22
Environmental Monitoring Best Practices	23
Envelope Monitoring Best Practices	24
Runtime Monitoring Best Practices	25
Current Monitoring Best Practices	25
Resources	26
About the Authors	28

Introduction

The energy required to operate buildings in the United States is the largest sector of our energy use and represents about 40% of U.S. energy demand.¹ Measuring building performance can help facility staff better manage this energy use. The focus of this best practices guide is on monitoring strategies and techniques that can be utilized by building professionals looking to reduce energy use and optimize performance of their facilities.

This guide includes measurement approaches for a variety of building systems including lighting, HVAC, indoor air quality, and plug loads, in addition to methods for quantifying savings. The Data Logging Best Practices section on page 18 contains more detailed pointers for successful monitoring studies. We will begin by exploring the topic of whole-building monitoring.



¹ Buildings Energy Data Book, U.S. Department of Energy: <http://buildingsdatabook.eren.doe.gov/ChapterIntro1.aspx>

Whole-Building Power Monitoring

Similar to tracking your vehicle's miles per gallon fuel consumption rate, looking at whole-building power usage can provide an early alert to developing problems and performance changes.

Monitoring whole-building power or energy usage over time can deliver many insights into a facility's performance. Similar to tracking your vehicle's miles per gallon fuel consumption rate, looking at whole-building power usage can provide an early alert to developing problems and performance changes. Whole-building data can be collected for any utility service (electricity, natural gas, water, central steam...), and can be utilized in a variety of ways. Analyzing the data can direct building professionals to opportunities for achieving energy savings or help verify the effectiveness of implemented energy efficiency measures. Whole-building data can be used for the purpose of benchmarking a building to facilitate the comparison to other buildings of similar type. It can also be used to size renewable energy systems or to explore the potential of demand response or load shifting strategies. Additionally the relationship between weather conditions and a facility's energy use can be established using climate data, whole-building utility data, and simple regression models.

With smart meters, average power (kW) data is readily accessible from the local utility provider in intervals of 15-minute readings. In addition, a portable power logger can be temporarily installed on the facility's main panel to track usage. While these loggers will not provide data within utility-grade accuracy ranges, it is not unusual for their specifications to be within 1%. They typically provide the added benefits of a full spectrum of power-monitoring capabilities to record voltage, current, kW, kWh, power factor, etc., at a wide range of user-defined intervals.

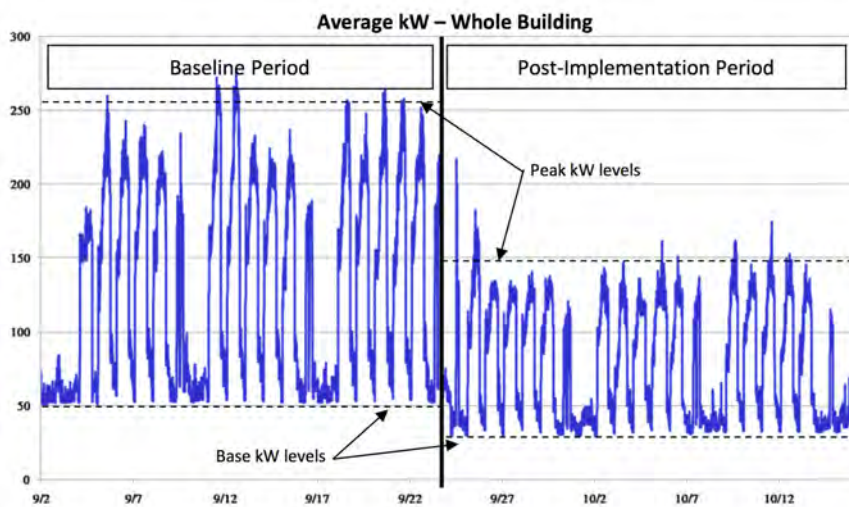

Figure 1: Reduction in Peak and Base Power Use

Figure 1 is an example of whole-building data collected over a six-week period. The first three weeks consists of a baseline period which provides a measure of the "before" conditions at the facility. In the middle of the data set, energy efficiency measures were implemented. The final three weeks of data on this graph visually captures the impact of the changes made at the facility. There has been a significant reduction in peak levels of power usage each day (from about 250 kW to about 150 kW) as well as a downward shift in the building's daily base kW levels (from about 50 kW to about 30 kW). The improvements made in this retrofit resulted in rather dramatic reductions in power usage levels that can easily be seen in whole-building data.

In addition to collecting total power usage for the whole building, it is often helpful to further disaggregate it, or break it down, into primary load types. This process was applied at a newly-constructed, state-of-the-art, energy efficient university building that was showing higher-than-expected energy use. Many data-logging power meters were deployed in an effort to isolate lighting systems, the chiller, other mechanical equipment, renewable energy sources and miscellaneous loads.

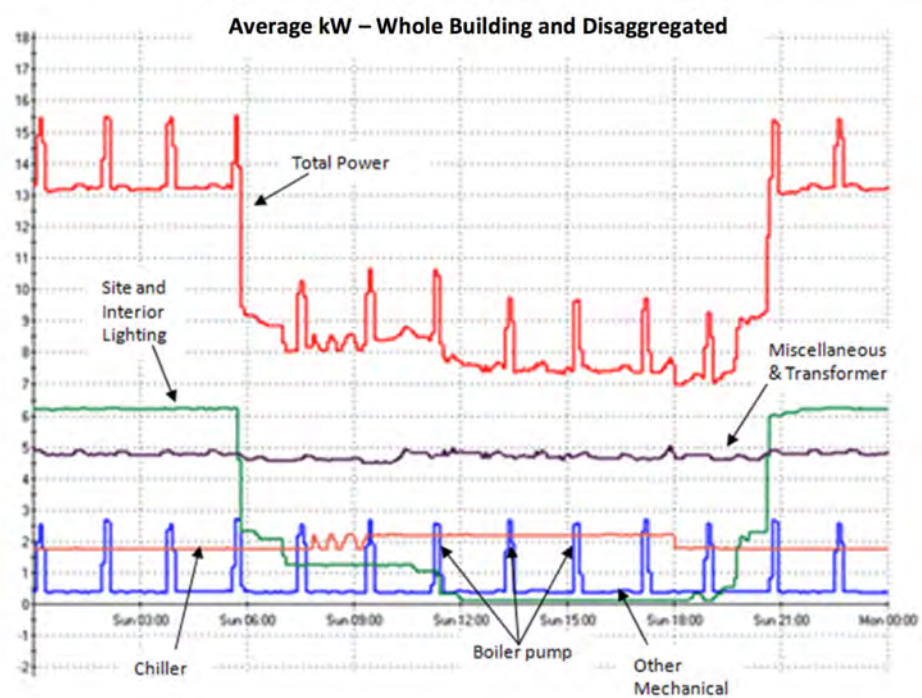

Figure 2: Whole Building and Load Disaggregation Analysis

The graph in Figure 2 shows the total building power (minus the renewable energy contribution) and power of the major system types for one full day from midnight to midnight. The first thing that jumps out as being unusual is that total power (in dark red) is at its highest levels at night. This is due to the fact that the facility includes the night lighting for an adjacent parking lot.

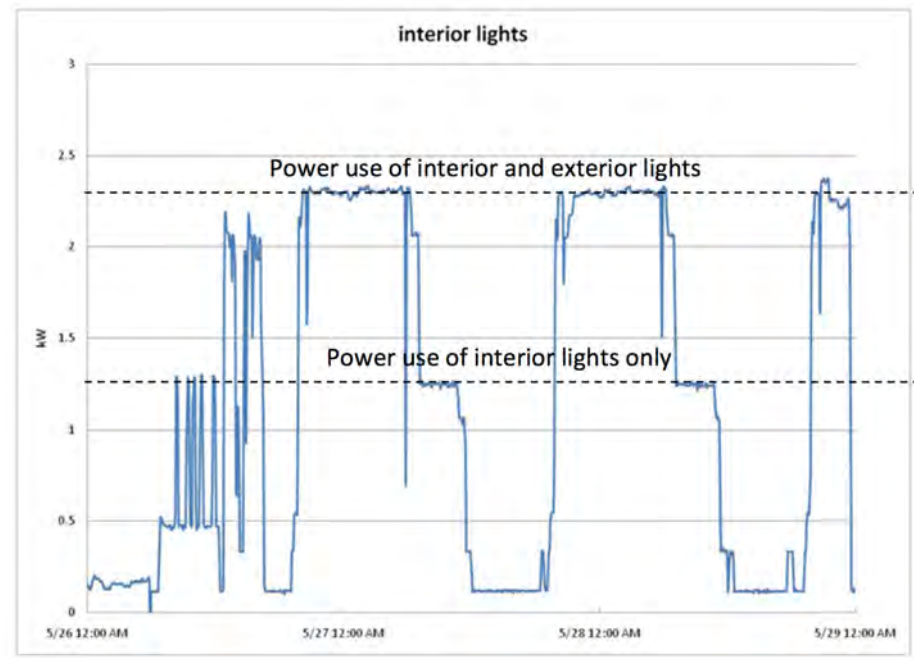

Figure 3: Interior Lights Power Use

When the exterior lighting is subtracted from the total lighting power, the graph in Figure 3 is produced. This shows the source of the higher-than-expected energy use: the interior lights dim over the day through daylighting controls but stay on for the entire night, even though the facility is unoccupied.

Equipment Monitoring – HVAC

Using portable data loggers to track, monitor, and verify temperatures are among their most beneficial and productive investigations.

Heating, ventilation and air conditioning (HVAC) systems are typically among the largest energy consumers in commercial buildings. As a result, improving their efficiency is an especially effective way to reduce energy use and the costs associated with it. From the system's key components including chillers, boilers, air handlers, packaged systems, economizers, fans, motors and duct work, to the finer points of scheduling and control systems, looking closely at HVAC system operation presents opportunities to benefit building owners, facility managers, and occupants.

With the multifaceted and ever-changing needs associated with maintaining indoor air quality and providing thermal comfort, HVAC systems comprise an equally complex interaction of individual components and dynamic, interdependent systems. While a building's energy management system (EMS) plays a vital role in monitoring and controlling many functions, the system's age, complexity or functionality can present limitations to readily-accessible data. Portable data loggers can be instrumental in filling in those gaps of information and also in verifying proper EMS sequences of operation and control strategies.

Some HVAC data analysis applications:

- Verify scheduling of equipment operation to coincide with actual facility needs.
- Verify sensor calibration, including thermostats for zone control.
- Eliminate simultaneous heating and cooling by verifying operation of multiple zones that serve a single large area.
- Verify control sequences, including optimal start and stop times associated with warm-up and cool-down requirements for the building, temperature-based reset strategies, and boiler and chiller lockout temperatures.
- Evaluate economizer performance based on relevant temperatures and damper positions.
- Monitor individual equipment for motor over-cycling, and variable speed drive control.
- Balance air and water systems, examining flow rates, pressures, and temperatures.

One of the most critical and prevalent parameters across the full spectrum of HVAC systems is temperature – outside air, mixed air, return air, supply air, discharge air, chilled water, condenser water, heating water, temperature stratification issues, etc. Using portable data loggers to track, monitor, and verify temperatures are among their most beneficial and productive investigations.

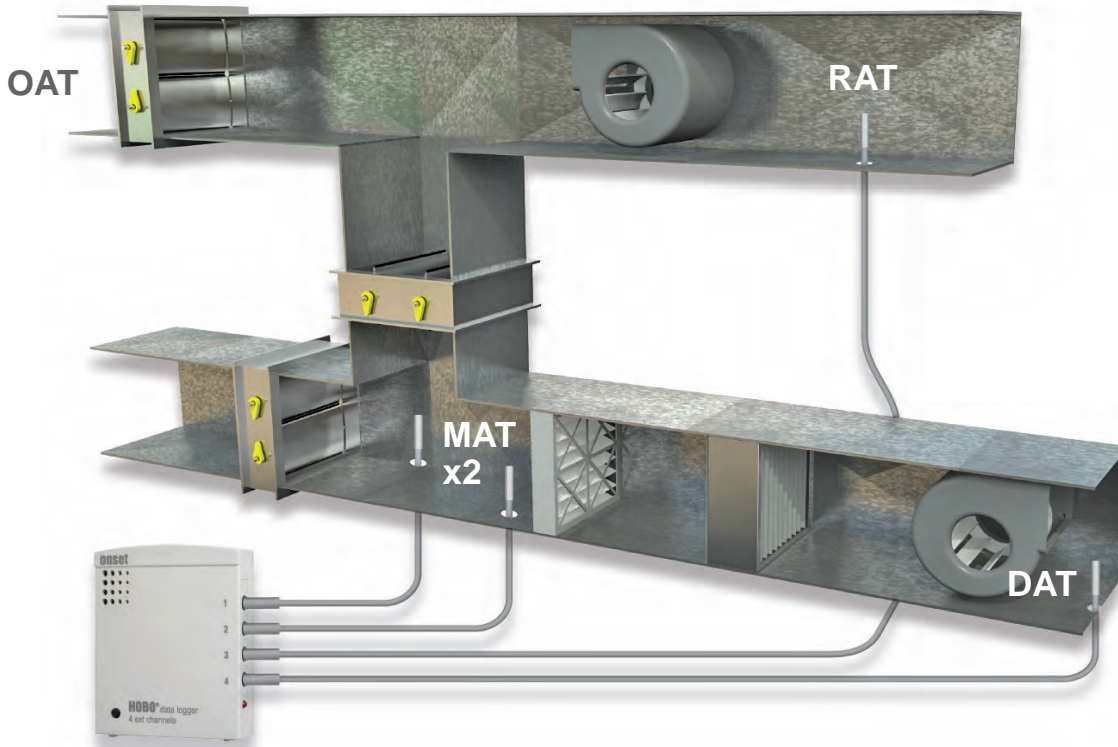

Four-channel logger deployment for ventilation air control verification

This monitoring project verified proper control in a zone. The building control system includes temperature setpoints for occupied periods as well as temperature setbacks for unoccupied periods. In Figure 4, the data collected demonstrates that during occupied hours, the controls kept the space within the dashed-line range in the graph, between about 68 to 72 degrees F. During unoccupied periods of time, the control system allowed the zone temperature to rise or fall outside of that narrow band in order to conserve energy, but maintained a range between 60-80 degrees F.

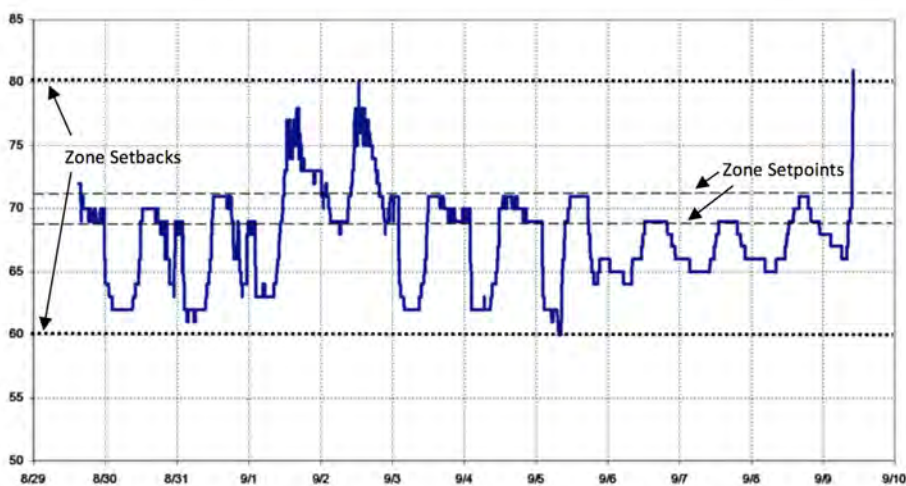

Figure 4: Proper Function of Zone Temperature Setpoints and Setbacks

Equipment Monitoring – Plug Loads



Plug loads are among the fastest growing sources of energy use in commercial buildings today, with office equipment and other miscellaneous plug loads consuming more than 20% of electricity in California's offices.² Computers, monitors, imaging equipment, and server rooms lead the pack as high energy-use offenders, followed by task lighting, space heaters, projectors, TVs, vending machines, kitchen equipment, and even cell phone chargers. Computer server rooms fall into this category and are one of the fastest growing energy systems in the US.³

Plug-in devices often have the ability to operate at various power levels including active, standby, sleep, and off modes (nomenclature varies by manufacturer) – each using decreasing amounts of power. A device that is reduced to 'standby' mode (screen saver on a computer, for instance) is still likely to be consuming a significant percentage of its fully-active power usage, as it is available to begin performing immediately upon request by the user. In 'sleep' mode, the equipment has been powered down further, and the user will experience a short delay while it returns to its active mode. Even in 'off' mode, some devices continue to consume power. These so-called vampire or parasitic loads are typically associated with instant-on capabilities, internal clocks, battery charging, LCD displays, or LED lights.

As is true in all categories of energy efficiency efforts, it is beneficial to focus first on large energy uses that have a correspondingly high energy savings potential. While this document and other resources can highlight some of the typically-worst offenders, it is beneficial to measure and benchmark the facility's actual equipment and operations. There are a number of commercially-available types of logging equipment suitable for the task.

While power-monitoring equipment similar to that discussed in the whole-building section of this guide can be utilized to monitor at the sub-panel or individual circuit level, extremely user-friendly meters that literally "plug in" between the load and the wall outlet are useful for monitoring plug loads. The process for initiating logging generally consists of plugging the load to be monitored into the plug load meter, and then plugging the meter into a standard wall outlet. It is not unusual to be able to measure voltage, current, and power factor along with wattage and kilowatt-hours with these meters. While the meter is connected, one can observe the real-time values on the meter's display, along with accumulated totals for the monitoring period. Some meters do not collect and log interval data over time; they strictly provide instantaneous readings and the total accumulated. Other plug-load power meters have built-in data logging capabilities and do record over time.

² Office Plug Load Field Monitoring Report, PIER Report April 2011: <http://www.energy.ca.gov/2011publications/CEC-500-2011-010/CEC-500-2011-010.pdf>

³ Growth in Data Center Electricity Use 2005 to 2010, Analytics Press: <http://www.analyticspress.com/datacenters.html>

Figure 5 contains a graph of data collected at an office workstation. The graph shows the varying power draw of a desktop computer. There are times when the computer is in a standby (screen-saver) or sleep mode. There are also occasions when the computer is actively in use and the power levels are at their highest. The meter used for this study recorded, volts, amps, power factor and power.

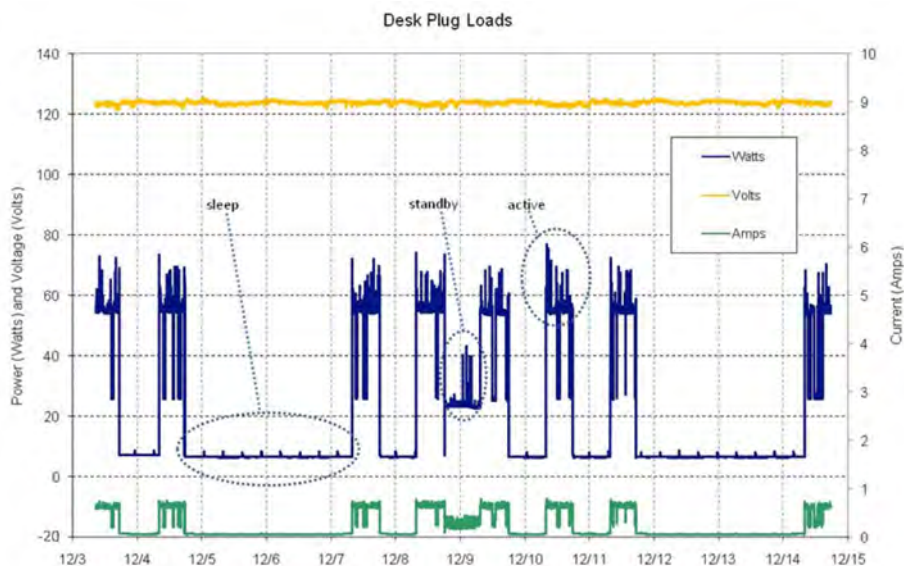

Figure 5: Variation of Desktop Computer Plug Load

Lighting Systems Monitoring



The portion of a commercial building's energy consumption that is attributable to lighting will, of course, vary among building types, locations, building functions, and other variables. What is unquestionable, though, is that lighting is a major contributor to total energy costs, typically representing 20 to 50%.⁴ Shifting to energy-efficient lighting is generally considered the easiest and most profitable investment compared to other energy-saving opportunities applicable to commercial building systems. Lighting energy use can be significantly reduced while still maintaining or even improving function, aesthetics, and productivity. An often overlooked additional benefit to upgrading to newer, higher-efficiency lighting is the reduced heat gain which leads to decreased demands on the building's cooling and ventilation system. While a portion of this benefit may be offset during heating mode operation, it is worth noting that inefficient lighting systems are not the most cost-effective way to heat a space.

Lighting Power Density (in watts/square feet), illumination levels (in foot-candles or lux), and operating hours are key measures for identifying energy efficiency opportunities. Many energy codes specify limits on Lighting Power Density according to space use or building type. The Illuminating Engineers Society provides recommended illumination levels.⁵

The two main approaches to reducing lighting energy use involve reducing power levels or operating hours. Portable data loggers are particularly well-suited for investigating opportunities related to lighting schedules and occupancy-based lighting controls, as well as verifying the proper operation of systems and controls that are already in place. As demonstrated above in the whole-building section, a lighting system can be operating in an unintended and inefficient way. And it is easy to evaluate lighting operating hours without the need to enlist the expertise of an electrician to install power-monitoring equipment.

Occupancy sensor lighting controls can save energy by automatically turning off lights during periods of time that the space is unoccupied. They are ideal for zones with irregular use or areas that are unoccupied at least half of the normal operating hours. Areas that are likely to be good candidates include rest rooms, stock rooms, conference rooms, and garages.



HOBO UX90-005 and UX90-006
occupancy/light data loggers

Monitoring both light and occupancy in a space is an excellent job for status-type of data loggers. Rather than logging light levels at regular intervals (one minute, five minutes or perhaps every fifteen minutes), it can be much more efficient and effective to log only when a change in light condition occurs. This status data is frequently presented as a 1 or a 0 to indicate on or off (or occupied or unoccupied) respectively. See Figure 6. These 1 or 0 values can then be manipulated in a spreadsheet program to evaluate when lights are on versus when they're off in conjunction with when occupancy is or is not detected. Obviously, the key combination to be determined is how much of the time are the lights on while no one is occupying the space. Also to be noted is when the space is occupied and the lights are off. Spreadsheet formulas and shortcuts can shorten the data evaluation process tremendously, but it can still be complicated and time-consuming.

⁴ California Commercial End-Use Survey, California Energy Commission <http://www.energy.ca.gov/ceus/>

⁵ Lighting Power Density for Whole Building or Space Types, Illuminating Engineer Society: <http://lpd.ies.org/cgi-bin/lpd/lpdhome.pl>

#	Time, GMT-07:00	Light	Occupancy	Light On & Unocc
1	04/02/13 07:40:07 AM	1.00	1.00	0.00
2	04/02/13 07:40:37 AM	0.00		
3	04/02/13 07:40:38 AM	1.00		
4	04/02/13 07:46:31 AM		0.00	1.00
5	04/02/13 07:47:09 AM		1.00	0.00
6	04/02/13 07:59:42 AM		0.00	1.00
7	04/02/13 08:09:15 AM		1.00	0.00
8	04/02/13 08:20:25 AM		0.00	1.00
9	04/02/13 08:22:41 AM		1.00	0.00
10	04/02/13 08:30:30 AM		0.00	1.00
11	04/02/13 08:37:38 AM		1.00	0.00
12	04/02/13 08:44:02 AM		0.00	1.00
13	04/02/13 09:47:15 AM		1.00	0.00
14	04/02/13 09:53:57 AM		0.00	1.00
15	04/02/13 09:57:29 AM		1.00	0.00
16	04/02/13 10:10:07 AM		0.00	1.00
17	04/02/13 10:14:23 AM		1.00	0.00
18	04/02/13 10:22:06 AM		0.00	1.00
19	04/02/13 10:49:14 AM		1.00	0.00
20	04/02/13 11:03:03 AM		0.00	1.00
21	04/02/13 11:22:23 AM		1.00	0.00
22	04/02/13 11:28:40 AM		0.00	1.00
23	04/02/13 11:51:27 AM		1.00	0.00
24	04/02/13 12:02:20 PM		0.00	1.00
25	04/02/13 12:14:26 PM		1.00	0.00

Figure 6: Table of Light and Occupancy Raw Data

Some loggers incorporate more sophisticated capabilities and make the job of analyzing the data much easier by calculating statistics and displaying graphs that provide immediate and visual representation of the potential energy-savings opportunity.

Some loggers incorporate more sophisticated capabilities and make the job of analyzing the data much easier by calculating statistics and displaying graphs that provide immediate and visual representation of the potential energy-savings opportunity. An integrated light/occupancy logger with such advanced capability was placed in one of the public restrooms inside of a commercial office building with an occupancy schedule that spans 8 AM to 5 PM Monday thru Friday. The objective was to assess the potential energy savings to be achieved with occupancy-based controls.

Figure 7 contains a graph depicting the entire monitoring period. And the energy-savings opportunity is evident. The X axis is time, while the Y axis ranges from 0 to 1, with 1 representing periods when the lights are on and the space is unoccupied. Note that the lights are always on, even when the space is unoccupied during the evenings and weekend. The graph easily communicates at a glance the energy-saving opportunity that is present in this space. While there is some additional benefit to be derived by utilizing an occupancy sensor to turn off lights during unoccupied periods of the work day in this rest room, there is even greater savings to be realized by scheduling the lights off during hours that the building is closed at night and on the weekends.

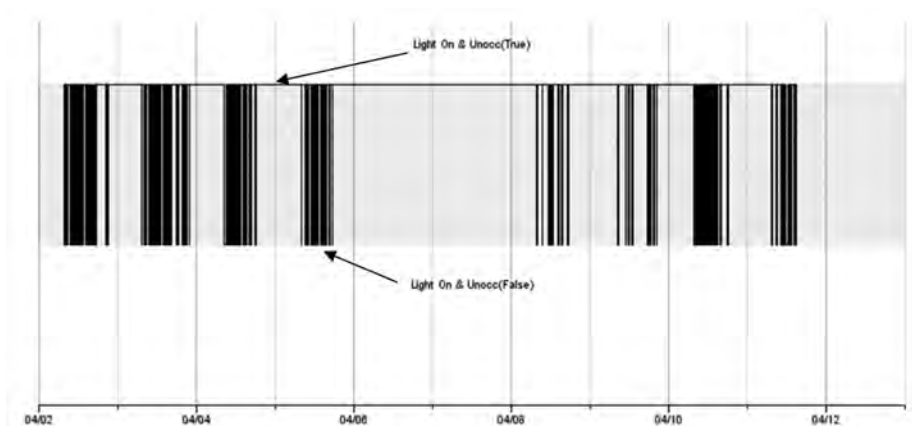

Figure 7: Occupancy Sensor Energy-Savings Analysis

Indoor Air Quality (IAQ) has been identified by the Environmental Protection Agency as one of the top five most urgent environmental risks to public health.

Environmental Monitoring

Maintaining the temperature, humidity, and other environmental parameters inside of a building is an occupant health and comfort issue as well as an energy issue. Indoor Air Quality (IAQ) has been identified by the Environmental Protection Agency as one of the top five most urgent environmental risks to public health.⁶ With the majority of Americans spending the bulk of their time in enclosed environments, the effects of indoor air pollution can be greater than that from outdoor air pollution. Common indoor air contaminants and sources include carbon monoxide, carbon dioxide, molds and bacteria, tobacco smoke, outdoor air pollutants such as pollen and dust, and volatile organic compounds emitted from a wide range of products such as paints, cleaning supplies, pesticides, building materials and furnishings, and office equipment.

Building codes define the appropriate ventilation rates for specific facility types. Many of these standards reference ASHRAE's Guideline 62.1: Ventilation for Acceptable Indoor Air Quality. The document includes operations and maintenance guidance for building operators regarding the mitigation of many IAQ problems.

To ensure that minimum ventilation requirements are met, frequently the HVAC system supply air is based on assumed rather than actual occupancy. This often results in over-ventilation, wasting both money and energy. In addition to the ventilation equipment's unnecessary runtime, excessive quantities of outside air are also being heated or cooled.

Demand-controlled ventilation (DCV) systems adjust outside air supply based on occupancy levels and the specific ventilation demands being created. Spaces that most typically can benefit from DCV strategies include assembly spaces that are designed for large numbers of people (with correspondingly high outside air requirements) but are frequently only partially occupied - such as theaters, gymnasiums, auditoriums, conference rooms, and classrooms. Similarly, vehicle traffic patterns in parking garages vary from the maximum levels for which their exhaust systems are designed. Actively controlling the ventilation system in these types of spaces provides the opportunity to maintain air quality while saving energy.

DCV systems can be based on sensors that monitor actual occupancy levels with infrared or ultrasound sensors or occupant-counting techniques such as turnstiles, ticket sales, etc. Other parameters that can be used as a proxy for occupancy include carbon dioxide (CO₂) sensors as an indication of number of occupants in a space or carbon monoxide (CO) sensors to monitor vehicle exhaust levels in a garage.



Telaire 7001 CO₂ Sensor

⁶ Indoor Air Quality in Commercial and Institutional Buildings, OSHA: <http://www.osha.gov/Publications/3430indoor-air-quality-sm.pdf>

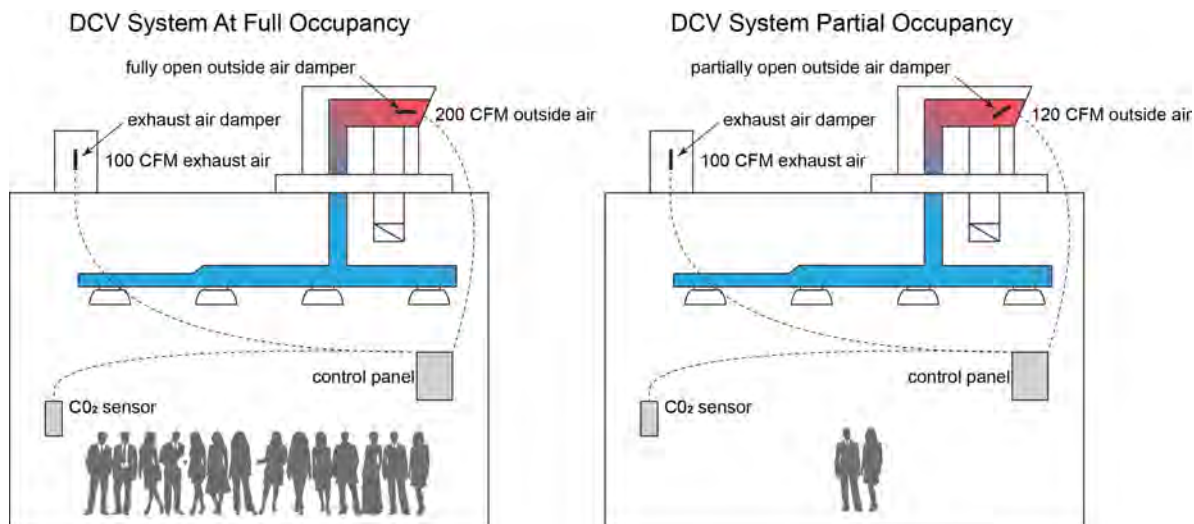

The graph in Figure 8 is the result of using carbon monoxide data loggers to measure CO levels in a commercial office building’s parking garage. Following installation of a DCV system, the space was monitored to ensure that vehicle exhaust levels were being maintained at safe levels. Occupancy patterns are evident in the data, with CO levels typically increasing in the garage at the beginning and end of each work day as vehicles enter or leave the space. Significant energy savings were realized with a shift from 24/7 exhaust fan operation to a mode of fans cycling on when CO levels exceed a given threshold (50 parts per million in this case).

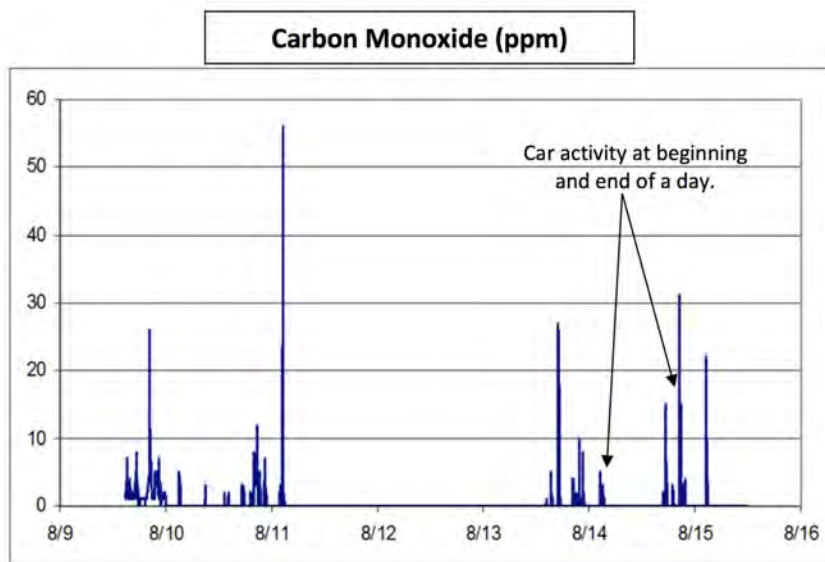

Figure 8: Garage Demand-Controlled Ventilation

Building Envelope Monitoring

Minimizing heat transfer through the building's walls, roof, windows and foundation reduces the need for both heating and cooling.

As the interface between the interior of the building and the outdoor environment, the building envelope serves as a key defensive thermal barrier, having a critically important impact on the amount of energy needed to maintain indoor comfort. Minimizing heat transfer through the building's walls, roof, windows and foundation reduces the need for both heating and cooling. The building envelope can significantly impact HVAC and lighting requirements, typically the two largest end uses of energy in commercial buildings.

Data loggers are useful in tracking parameters that provide insight into envelope performance. Other sections of this guide address some of their specific abilities associated with monitoring temperature and light levels. In the example graphed in Figure 9, loggers were utilized to determine the source of moisture in a room.

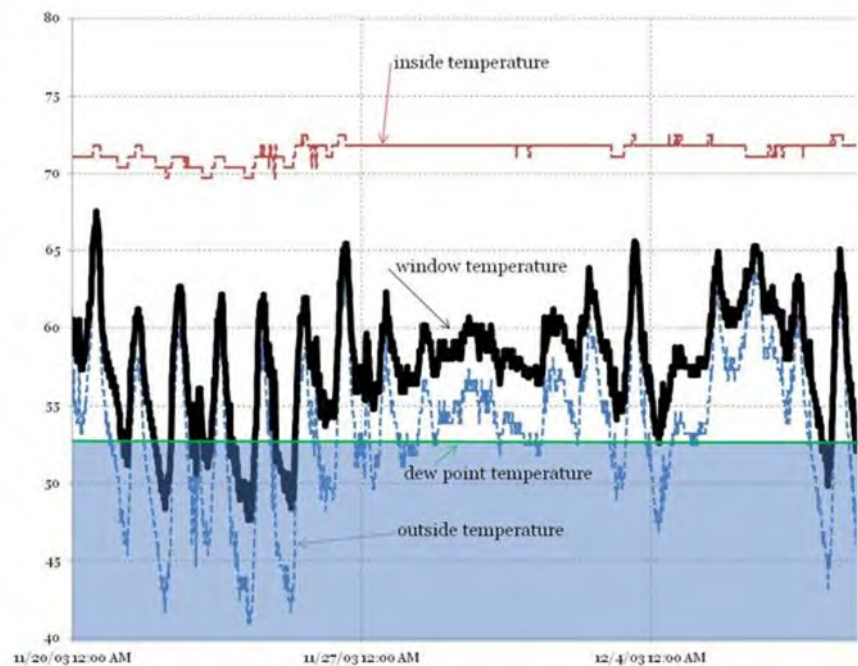
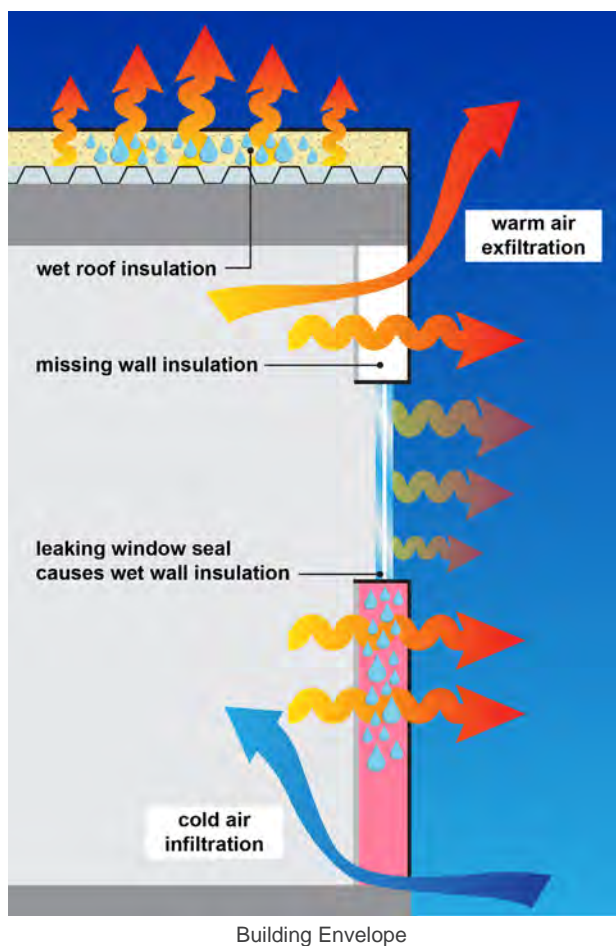

Figure 9: Moisture Investigation

Condensation in a building usually occurs when warm air comes into contact with a cold surface. The water vapor present in the warm, humid air will condense into liquid upon contact with a surface that is below the air's dew point temperature. The same phenomenon occurs when a glass filled with cold water begins to "sweat" during a warm, humid summer afternoon.

Given the inside air temperature as monitored in Figure 9, and with relative humidity in this particular space at 50%, the dew point for the air is 53 degrees F (green line). Any time the surface temperature of the single-glazed window decreases to that level, condensation will form. As depicted in the graph, this occurs when the black trend line falls into the blue shaded region.

Dew point temperature can be measured, or can be calculated based on measurements of air temperature and relative humidity. The key to controlling moisture in buildings is monitoring surface temperatures, space temperature, and space humidity. By ensuring that room conditions remain above the dew point at the coldest interior surfaces within the building, condensation can be avoided. The more prevalent use of radiant cooling with chilled ceilings, floors, and beams presents an increased importance on such monitoring.



Quantifying energy savings comes down to evaluating the reduction in power (kW) and/or hours (h) of operation, and is typically calculated over an annual period.

Quantify Energy Savings

Unlike some parameters, energy savings cannot be determined with a single measurement. Instead, energy savings are quantified in relation to a reference situation. For example, energy savings is the difference between energy consumption before and after an energy efficiency measure is implemented. In the energy-savings equation (below), the pre-retrofit condition is identified as the “baseline” condition. Baseline can refer to any number of conditions that are compared to the proposed condition including the energy use of the existing equipment, the energy use of code-compliant equipment, or the energy use of equipment that qualifies for incentives.

$$\text{kWh saved} = \text{kWh baseline} - \text{kWh post-retrofit}$$

Quantifying energy savings comes down to evaluating the reduction in power (kW) and/or hours (h) of operation, and is typically calculated over an annual period. The three main approaches addressed in this guide range from relatively simple to more complex, the suitability of each being directly related to the nature of the energy efficiency measure being investigated and the complexity of the associated system type.

Quantify Savings Based on Runtime Hours:

There are many energy-saving opportunities associated with adjusting operating schedules such that equipment runs fewer hours. In these cases, power usage remains the same; the energy savings is strictly a result of reducing runtime hours.

Quantifying energy savings based on equipment runtime hours is well-suited for loads that draw a constant power level when they are on, such as fluorescent lighting without dimming capability and constant-load motors. Determining those hours of operation is an excellent application for status-type data loggers. The collected data will indicate when the equipment turns on and when it turns off, enabling calculation of the equipment’s operating hours.

An example of data that can be used to estimate the expected reduction of runtime hours is the occupancy study presented in the lighting section of this document. Data loggers provided insight into the amount of time lights were on while the room was unoccupied. Estimated energy savings would be attributed to reduction in runtime hours associated with the installation of occupancy sensors.

Evaluation of motor runtime with a motor status logger is another appropriate application and is illustrated in Figure 10. If a constant-speed fan’s initial condition is continuously on, and its operation is then adjusted to accommodate the occupied schedule of the building, the energy savings will be based on the product of the system power (kW) and the reduction in annual operating hours.

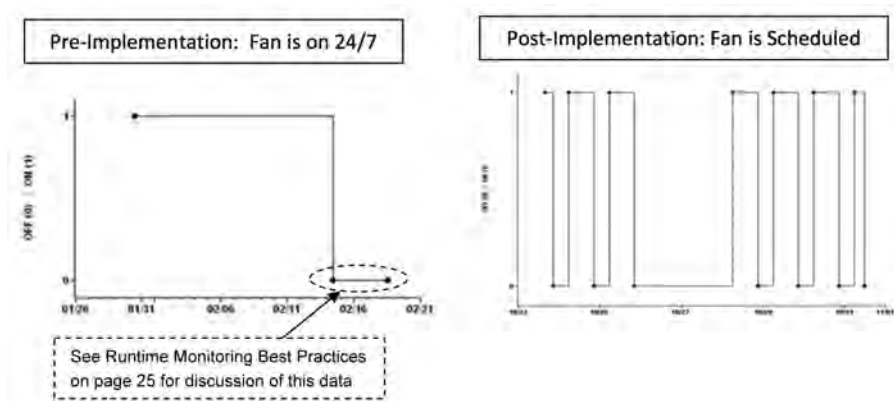

Figure 10: Pre- and Post-Implementation of Fan Schedule

In determining power estimates to be used in quantifying savings, be aware of the impacts that will affect actual kW compared to the motor nameplate or a lighting system's nominal wattage lamp rating. Motor nameplate values represent the full-load condition while the actual power used may be higher or lower than this wattage. Total power levels for a lighting fixture are a function of many variables including the type of ballast and the nominal wattage rating displayed on the lamp.

Much of a building's equipment operates at variable levels of power, some with distinct load stages (chillers) and others able to continually vary power based on load demand (dimnable lighting circuits or equipment controlled by a variable speed drive). For energy efficiency measures associated with reductions in these more complex and varying loads, more complete characterization of the power use is necessary. Monitoring either current (amperage) or power (kW) are the options; each has unique advantages for different applications.

Quantify Savings Based on Monitoring Current:

Compared to monitoring power, measuring current requires less equipment and less space inside of an electrical panel. Equipment to log amperage is typically less expensive and requires less time to install. While safety considerations are still paramount when electric panel access is involved, current monitoring does not require a connection to voltage. Current sensors or current transducers are placed around the circuits to be monitored and attached to the data logger.

Collecting data on the equipment's actual current draw as it varies over time provides a more thorough representation of the load profile presented by a component with multiple stages or controlled by variable speed drive. Assumptions will still be necessary for actual voltage and estimated power factor, but the ease of monitoring just current is a major benefit to this approach. By using factors or regressions to convert amperage data to power, this approach can be just as accurate as the data collected with a power meter.





Variable frequency, or speed drives.

In general, VFD's are used to:

- Match the speed of a drive to the process requirements
- Match the torque of a drive to the process requirements
- Save energy and improve efficiency

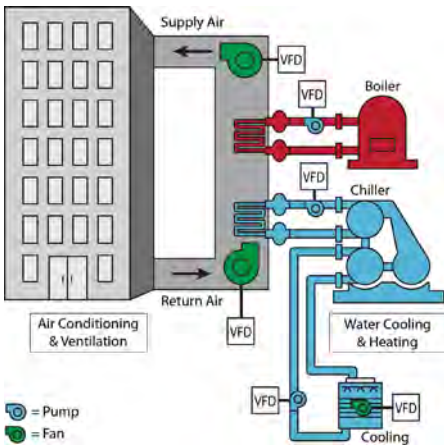

This current-monitoring approach was utilized to demonstrate savings associated with the installation of a variable speed drive and is presented in Figure 11. Baseline condition on the left depicts initial operation of the constant-speed fan at 5 amps. Operation after installation of a variable speed drive (VSD) is shown on the right and graphically represents the reduction in amperage levels. The equipment now is capable of varying in response to the actual load requirement, which is generally about 3 amps.

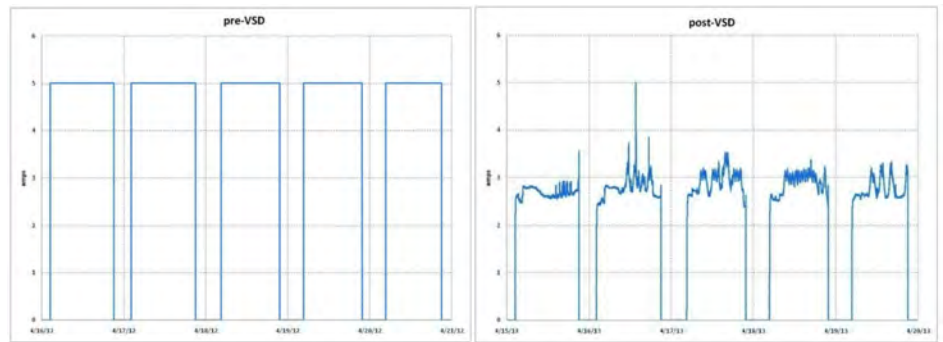

Figure 11: Pre- and Post-Implementation of Variable Speed Drive

For even more complicated or unpredictable loads including subpanels or whole-building loads, utilize power-monitoring equipment.

Quantify Savings Based on Monitoring Power:

Monitoring power directly is the most accurate method for quantifying energy savings. Additionally, the load characteristics of some equipment are more unpredictable or have complexities associated with variable power factors or changing Total Harmonic Distortion. Non-linear loads produce non-sinusoidal waveforms that necessitate the use of true RMS (root mean square) data loggers to obtain accurate power data.

Setup and installation of power loggers can be more complex and also presents challenges inherent in accessing electric panels (safety considerations and space restrictions), and the equipment cost can be substantially greater than current-monitoring equipment. In exchange, they provide detailed power and energy data for monitoring and analyzing whole building or individual loads. These data loggers measure voltage and current, and in addition to logging those values, they also calculate and provide an extensive spectrum of parameters that typically includes power (kW), energy (kWh), power factor, apparent power (kVA), and reactive power (kVAR).

True RMS power-logging equipment was utilized to investigate a building's total power draw and the key contributors to this total. Figure 12 presents pre-implementation data for a particularly hot summer day. The black line represents whole building, and blue is mechanical equipment. This building's thermal storage system was not operating properly. Peak kW levels were coinciding with the utility company's daytime peak demand periods where energy costs are at their highest rate.

Pre-Implementation: Deficient Thermal Storage System

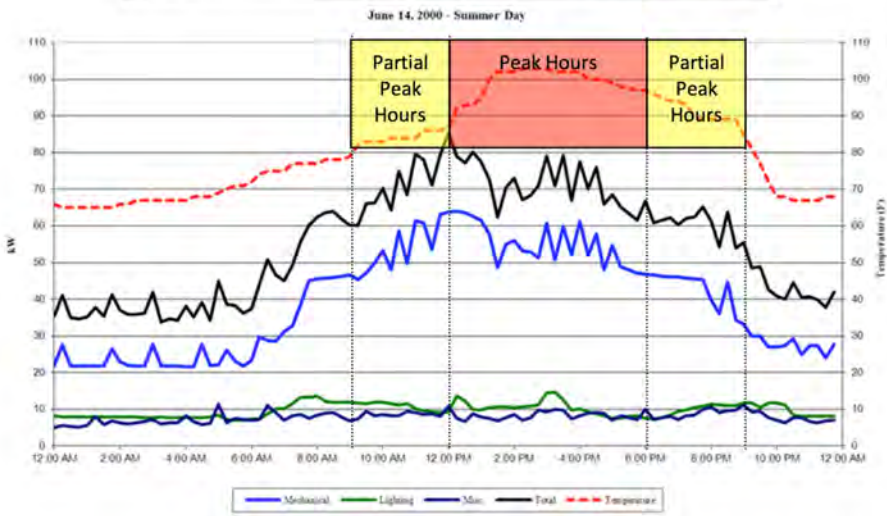

Figure 12: Peak Loads Occur During Utility Peak Demand Periods



After re-commissioning the building, load shift from the thermal storage system can be seen in Figure 13. Highest demand levels now occur during the evening off-peak periods associated with lower utility rates.

Post-Implementation: Thermal Storage System Load Shift

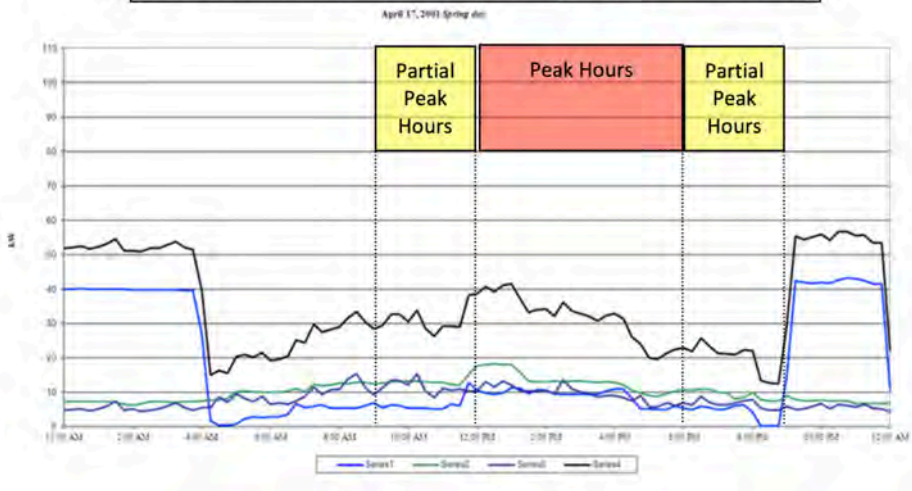
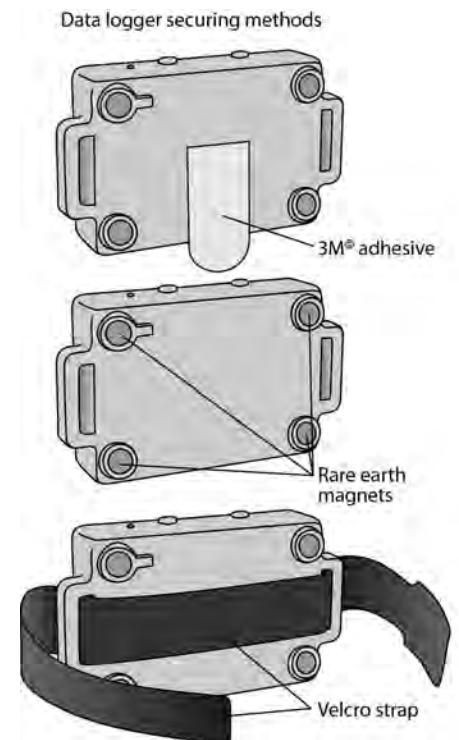

Figure 13: Peak Loads Shifted Out of Utility Peak Demand Periods

Data Logging Best Practices

General Best Practices:

- To initiate a data logging project, begin with the end in mind. Consider the overall objective of the study and what questions are to be answered with the data collected. Determine the scope of data logging activities accordingly.
- Collect as much data as necessary but no more than is needed. Key decisions include the length of monitoring period, the interval at which measurements are recorded, and the data parameters to be collected. Collect data at a suitable logging interval and over a sufficient time period that will include the full range of operation relevant to the specific project, inclusive of evening and weekend operation. What is appropriate will vary based on each individual situation. A minimum of two weeks of data allows for comparisons over the two weeks and the ability to identify operational anomalies.
- It is often advantageous to simultaneously monitor systems or components that operate interdependently in order to obtain operating data that is coincident. As an example, when collecting temperatures for an economizer function analysis, in addition to monitoring all temperatures simultaneously for comparative purposes, it is beneficial to also track supply fan operating status.
- When deploying multiple loggers whose data points are interrelated, data analysis will be much easier if all of the loggers have synchronized clocks, and are programmed to start at the same time and to collect measurements at the same recording intervals. Integrating multiple data sets with measurements collected at varying intervals can be extremely challenging within basic spreadsheet programs. And this is also true of combining interval data with on/off status data which has no set interval period associated with it.
- Universal Translator is a software tool developed by Pacific Gas and Electric Company available for free download at www.utonline.org. It is particularly powerful for analyzing large data sets, and for reconciling data from different or unsynchronized sources or data that has been recorded at varying intervals. It includes tools to filter data and calculate psychrometric properties as well as an array of modules to analyze economizers, light and plug loads, equipment runtime, etc.
- Keep safety considerations at the forefront when deploying loggers. Each individual situation will present its own inherent safety issues, with exposure to ladders, electrical circuits and rotating equipment typically among the top concerns.
- Inform the building operators where loggers will be installed on site. Facility staff unaware of data collection efforts may suspect the devices serve some nefarious purpose and remove them.
- Install loggers securely to prevent them from shifting or detaching during the study period, and label them with a project note or contact information. Often it is best for the loggers to be positioned such that they are as inconspicuous as possible. This helps prevent tampering with the loggers.
- Careful note-taking to document logger deployment details is critical. Many loggers have been lost because of inadequate field notes. The notes should include the exact location, the measurement intent, and a specific identifying number (like serial number) for each installed device, as well as the date and time the loggers were installed and removed.



Power Monitoring Best Practices:

- Safety is paramount, and this is most particularly important when logging electrical power. A qualified, licensed electrician should perform initial installation and removal of these data recorders. During the data-collection period, logging equipment should be secured within electrical enclosures or electrical rooms, and installed power meters should never be accessible to building occupants.
- Become familiar with logger and current transformer specifications and instructions for optimal placement to ensure the most accurate results.
- It is recommended that all three phases at the main panel be monitored rather than making assumptions about balanced loads. It is our experience that the power draw on different phases of a three-phase load is rarely equal.
- It is common to monitor power in 15-minute intervals, as this allows for easy correlation with data from utility meters. Shorter intervals may be advantageous in some situations when power is expected to vary greatly over short time periods.
- Because most power meters will provide amperage, voltage, and power factor values in addition to power (kW), it is often preferable to record these values along with the total power to make sure each contributing variable is consistent and reasonable over the entire study period.
- Before leaving the loggers for the duration of the monitoring period, ALWAYS verify proper installation of the logging equipment as well as correct configuration of the logger software. Look at the real-time data values being collected to ensure they are within reasonable ranges of expectations for the given load, and confirm that the logging equipment is set to monitor all of the points important for the study. During the logger installation period is the ideal time to determine that a current transducer is installed backwards or a voltage lead is not fully connected, or a data point is not included in the logger output, etc. It is NOT the opportune time to discover these issues a month later when the data collected is being analyzed, as it is often impossible to correct data from meters installed incorrectly.
- When a Variable Frequency Drive (VFD) or electronic ballast is being monitored, it is critical to install the power-logging equipment on the line (utility)-side of this equipment. The frequency and voltage on the load-side of the VFD or electronic ballast are outside the allowable range for most power meters and will cause inaccurate results.

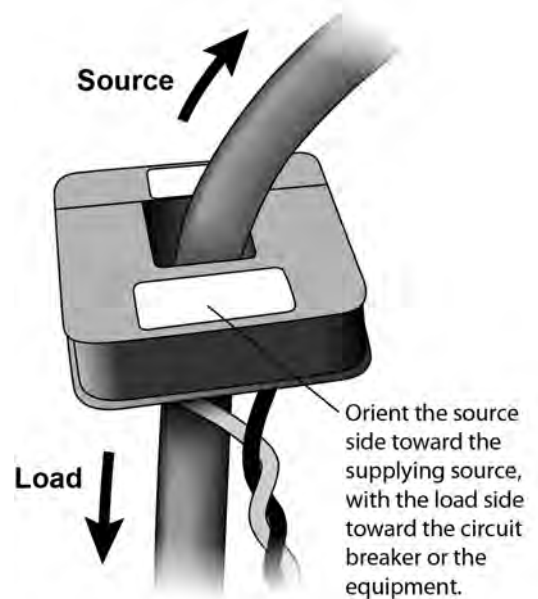

HVAC Monitoring Best Practices:

- Use various types of loggers and sensors within their specified operating parameters. As an example, many loggers are not weatherproof and must be protected from moisture or excessive temperature exposure.
- Ensure the sensor is registering temperature attributable solely to the parameter being monitored. Shield the sensor as necessary to avoid direct sun or other temperature sources that will potentially influence readings and result in erroneous data.
- Maintain consistency in logger model or sensor type across the study to provide uniformity of accuracy ranges and response times.
- Particularly if the project includes comparing temperatures or analyzing differential temperatures, it is critical to comparatively evaluate the sensors or probes prior to use in the study. One approach is to select only sensors and loggers that provide consistent results from a larger batch of equipment. Creating these “matched sets” of loggers and sensors may require that the devices record variation similar to what they will encounter during the actual study. In some cases this pre-study data can establish specific correction factors for each logger/sensor combination that will compensate for any accuracy discrepancies.
- Temperature sensors are often designed for specific applications and conditions. For instance, a high-range thermocouple is likely a best choice for a boiler study, but it will not be as accurate for the bulk of other HVAC applications. And some sensors can be damaged if exposed to extreme hot or cold conditions.
- Response time of the temperature sensor and reading stability are other considerations to be matched to the behavior of the system under study.
- When measuring the surface temperature of pipes related to hydronic systems, it is often best to use conductivity paste when strapping the sensor to the pipe to ensure good readings. After attaching the sensor to the pipe, it is often wise to place foam insulation over the sensor to buffer it from the room temperature conditions.

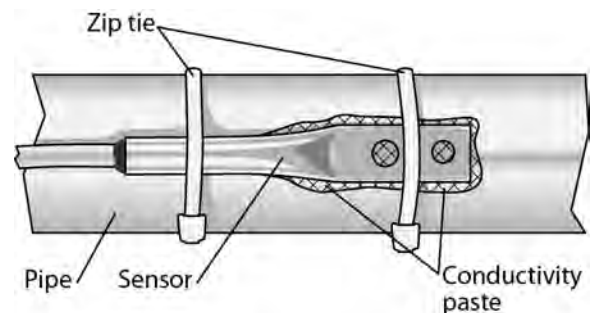
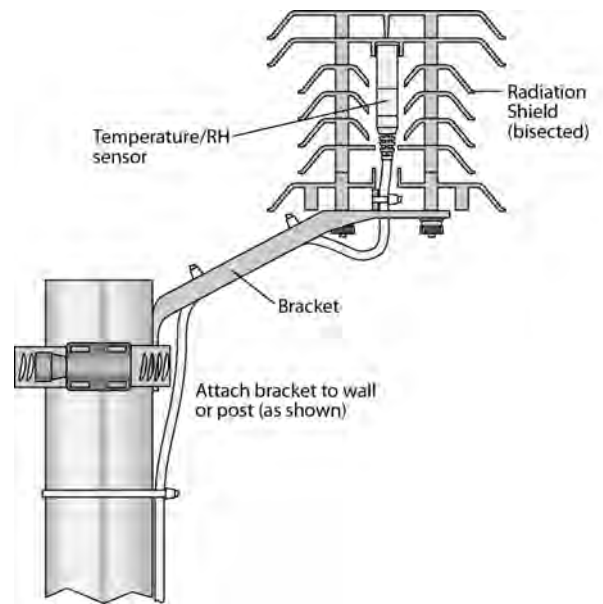

Plug Load Monitoring Best Practices:

- Plug-load studies can be approached by either monitoring accumulated energy over the study's duration or recording watts, amps, volts and power factor over time. Measuring accumulated energy is simple and easy but does not provide data on the operation of equipment at specific times. If this level of detail is required, it is best to use a data-logging power meter.
- Plug loads can be measured at the individual receptacle. This approach allows a study to focus on a single appliance, or if a plug strip is used, multiple appliances.
- Plug-loads can also be measured at the electrical subpanel where an individual circuit (breaker), combination of circuits or an entire panel can be monitored. Meters installed in electrical panels require the assistance of qualified electricians to insure that the meters are installed safely and accurately.



HOB0 UX90-001 State data logger monitoring plug load at the panel

Lighting Monitoring Best Practices:

- For accurate and useful data, it is critical to strategically position the logger in the space to be monitored. When monitoring occupancy in conjunction with a lighting study, occupancy detection will be accomplished with either ultrasonic or infrared sensors, each with their strengths and weaknesses. Check logger specifications and instructions to ensure accuracy of occupancy detection, and optimize logger location so it will detect only occupancy within the space of interest and not in adjacent spaces. Orient the logger so the light sensor is facing the light to be monitored. Ensure that the logger will not be able to sense light from another source (another fixture on a separate circuit, or daylight sources) that will compromise the validity of the study.
- To avoid logger tampering during the monitoring period, light loggers should be placed out of sight inside the light fixture being monitored.
- Do make sure that light loggers are not so close to the light source that the device is damaged by the heat.
- Many lighting loggers that provide analog data have poor accuracies and cannot be calibrated. These devices are appropriate for determining light status and gross variations in lighting operation, but should not be used for fine-tuning of lighting controls. It is best to use sensors with cosine and color corrections where high accuracy is required.
- In addition to observing how much time the lights are on with no occupancy, it is also a good idea to look at the opposite condition: "How often is the space occupied when the electric lights are off?" In some spaces with good daylighting or conscientious occupants, forcing the lights to a particular schedule would actually INCREASE energy usage!

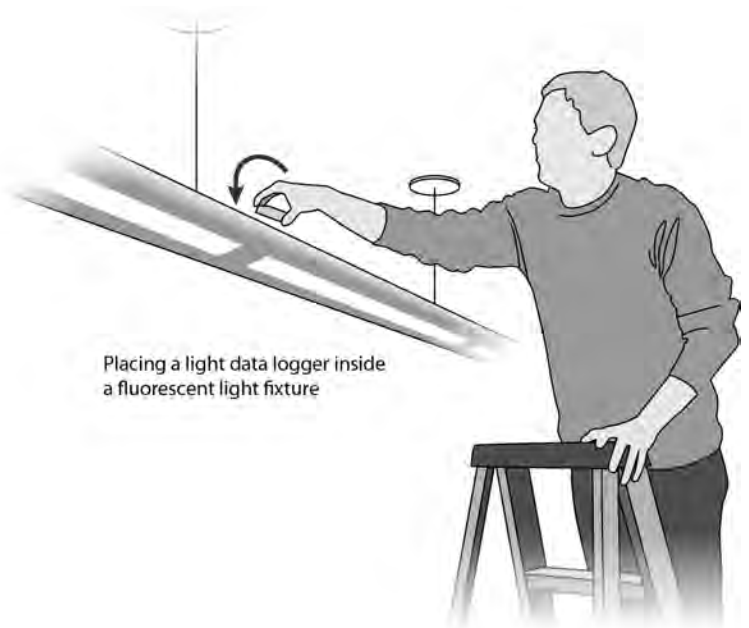

Environmental Monitoring Best Practices:

- While sensor placement is often one of the most important criteria for obtaining accurate, useful measurements in all data collection projects, it is especially so with environmental monitoring. Sensors can be subject to local concentrations of CO or CO₂ for instance, and may not represent the ventilation needs of the entire space. Because of this, the use of multiple sensors is appropriate for most Indoor Air Quality studies. Measuring at many locations will insure that pollutants are being removed effectively from the all portions of a space.
- For CO₂ studies, it is best to have a sensor in each occupied zone. Because the sensors are accessible, it is possible to get high readings from building occupants breathing on the sensor. Alternatively, the CO₂ sensor can be placed in the return air duct where it will be free from tampering.



Envelope Monitoring Best Practices:

- Envelope studies often require that the surface temperatures of building assemblies are monitored. It is important that data loggers are properly programmed for use with external sensors and that the temperature range of these sensors are appropriate for the expected conditions.
- To improve the accuracy of surface temperature studies, it may be best to place a small piece of foam insulation over the sensor to buffer the reading from the room temperature conditions.
- When measuring surface temperatures of glazing, the sensors must be located so they do not receive direct sun. If the sensor does receive solar gain, it will heat up from the solar gain and will not accurately report the glass surface temperature.
- Surface humidity levels cannot be measured accurately, as it is impossible to place the probe on the surface and get a valid reading. For these studies the air temperature and humidity near the surface is adequate, and the humidity level or dew point at the surface can be calculated with a psychrometric chart.
- When measuring light transmittance at windows, the inside and outside illuminance must be measured. One approach to this study is to measure horizontal illuminance inside and outside the window and include adjustments in the transmittance calculations that factor in the dynamic nature of the solar angle of incidence to the glass as the sun changes position over each day. Another approach is to measure the inside and outside light levels normal to the sun at a window that is receiving direct sun. For the latter test, a one-time reading will suffice, but adjustments must also be made for solar angle of incidence.

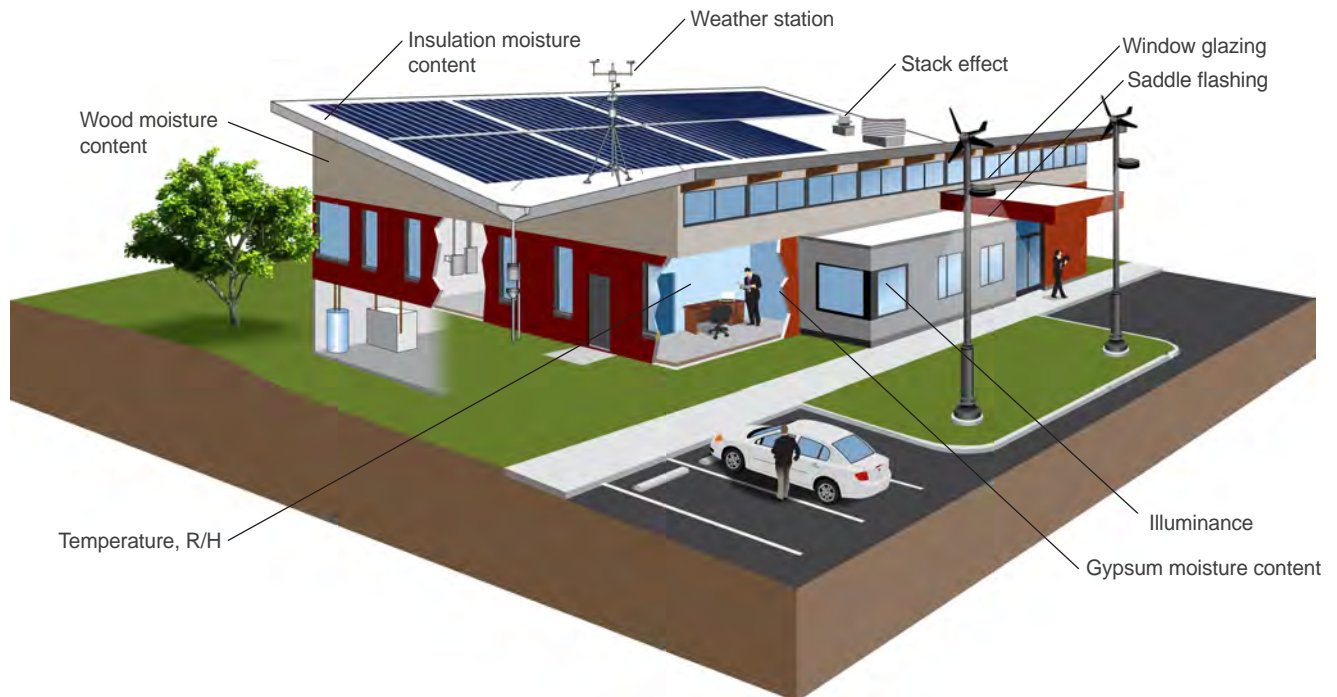

Runtime Monitoring Best Practices:

- For useful and accurate motor runtime hours, appropriate placement of the data logger is particularly important. For motor loggers that track on/off status based on the detection of the equipment's magnetic field, confirm that the logger's placement enables it to register the distinction between on and off for the motor under study, and that it is not being erroneously impacted by the field produced by nearby equipment. Similarly, lighting status loggers need to be installed so that they register only the condition of the electric lights under study and not light from neighboring electric or daylight sources.
- Taking detailed notes to document logger deployment details such as the time installed and also removed from the field can prevent potential errors in final data analysis. In the case of the pre-implementation data of the fan in Figure 10, (page 15) the "off" condition exhibited by the motor runtime logger on 2/14 correctly reflects that no magnetic field is being detected; accurate analysis of this data is based on knowing this "off" status corresponds to the removal of the logger from the equipment as opposed to an actual shutdown of the fan.



Current Monitoring Best Practices:

- Collect data across the full range of variable operation or to include each level of operation for multi-stage equipment.
- For amperage studies, a fast sampling rate of one minute (or faster) is typically recommended in order to detect all variation of the load.
- To increase the accuracy of amperage-to-power conversions, simultaneous power measurements can be collected while current is being continuously monitored. A regression can be used to develop a mathematical relationship between the varying amperage and its correlating power draw. For more detail on this process, see Using Current as Proxy for Power in Resources section (page 26).

Resources

ENVELOPE:

Psychrometric Chart Use, University of Connecticut
http://www.sp.uconn.edu/~mdarre/NE-127/NewFiles/psychrometric_inset.html

Predicting Condensation, University of Georgia
<http://www.caes.uga.edu/departments/bae/extension/handbook/documents/moisture%20control.pdf>

ENVIRONMENTAL:

ASHRAE's Guideline 62.1: Ventilation for Acceptable Indoor Air Quality
www.ashrae.org

Indoor Air Quality, Energy Design Resources:
http://www.energydesignresources.com/media/1750/edr_designbriefs_indoorairquality.pdf

Demand Control Ventilation, US Department of Energy, Energy Efficiency & Renewable Energy:
http://www.energycodes.gov/sites/default/files/documents/cn_demand_control_ventilation.pdf

GENERAL:

ASHRAE 90.1-2010 Energy Standard for Buildings Except Low-Rise Residential Buildings
www.ashrae.org

Buildings Energy Data Book, US Department of Energy, 2011
<http://buildingsdatabook.eren.doe.gov/default.aspx>

Energy Design Resources
<http://www.energydesignresources.com/>

International Performance Measurement and Verification Protocol
www.evo-world.org

No-Cost/Low-Cost Energy Savings Guide, International Facility Management Association:
<http://www.ifmafoundation.org/documents/public/NoCostLowCostGuide.pdf>

Portable Data loggers: Diagnostic Monitoring Tools for Energy-Efficient Building Operation
http://www.peci.org/sites/default/files/peci_dxmonitoring1_0302.pdf

Universal Translator (free software for managing, processing and graphing data)
www.utoonline.org

Washington State University Energy Program:
<http://www.energy.wsu.edu/>

LIGHTING:

Lighting Development, Adoption – US Department of Energy, Energy Efficiency & Renewable Energy
http://www.energycodes.gov/sites/default/files/documents/Lighting_Resource_Guide.pdf

Lighting Power Density for Whole Building or Space Types, Illuminating Engineer Society:
<http://lpd.ies.org/cgi-bin/lpd/lpdhome.pl>

Recommended illumination levels, Illuminating Engineer Society:
<http://www.ncat.org/energy/images/IES%20footcandles.pdf>

Table of Standard Fixture Wattages:
https://www.sce.com/NR/rdonlyres/9EB5180F-D655-43C1-A8BC-D19FCF76DB6F/0/B_Standard_Fixture_Watts.pdf

PLUG LOAD:

Plug Load Best Practices Guide, New Buildings Institute
<http://newbuildings.org/sites/default/files/PlugLoadBestPracticesGuide.pdf>

QUANTIFY ENERGY SAVINGS:

Using Current as Proxy for Power, Pacific Gas & Electric Company:
http://www.pge.com/includes/docs/pdfs/about/edusafety/training/pec/toolbox/tll/apnotes/using_current_as_proxy_for_power.pdf

About the Authors



Dawn Collins is a mechanical engineer whose experience spans across multiple facets of improving commercial building and industrial plant energy efficiency performance. She has consulted with clients to identify and implement cost-effective energy efficiency and demand reduction strategies in offices, retail businesses, hospitals, lodging, and university buildings, and has managed the performance monitoring and testing program for utility steam-generating units.

Dawn is a Certified Energy Auditor (Association of Energy Engineers) and has provided energy management engineering services including auditing, benchmarking, baseline models of operation, existing building commissioning, as well as post-implementation measurement and verification of savings.

Dawn has authored technical application guides detailing the effective use of performance analysis tools including data loggers and software programs, and has instructed customers of Pacific Gas & Electric's Pacific Energy Center on topics including power monitoring, ultrasonic flow measurement, and data collection techniques for a wide range of hand-held measurement equipment and data loggers.



Ryan Stroupe is the Building Performance Program Coordinator at the PG&E Pacific Energy Center, a publicly-funded facility in San Francisco operated by Pacific Gas & Electric. He teaches classes and consults with building professionals on a variety of issues including energy audits, building commissioning, monitoring protocols, measurement tool applications and architectural design.

Ryan oversees the PEC's Tool Lending Library, a free service that loans monitoring equipment to California energy customers. Also at the Center, Ryan has taught over 25 different classes on building measurement and energy-efficient design including a 5-day series on conducting energy audits for commercial buildings and a year-long intensive series on commissioning existing buildings.

Ryan has also taught for a number of colleges and universities including architecture courses at the California College of the Arts in San Francisco titled "Building Energy Systems" and "Energy Analysis". He teaches a class titled "The Building Envelope" for UC Berkeley Extension and is a regular instructor for the Sustainable Building Advisor Program. Ryan has also taught for CSU-East Bay, Academy of Art University, Foothill College and DeAnza Community College.

Ryan is actively involved with the US Green Building Council (USGBC) and has served as co-chair of the Northern California Chapter's Green Building Resources Committee. Ryan is a LEED accredited professional (USGBC) and a Certified Energy Auditor (Association of Energy Engineers). He is a product of the Masters of Architecture program at U. C. Berkeley.

Other informational resources available from Onset:

Analyzing Air Handling Unit Efficiency with Data Loggers

Operating a heating, ventilation and air conditioning (HVAC) system at optimum efficiency in a commercial setting is complicated, to say the least. There is a very real chance that any number of setpoints, levels, and feedbacks at boilers, chillers, pumps, fans, air delivery components and more can cause costly inefficiencies.

Finding Hidden Energy Waste with Data Loggers: 8 Cost-Saving Opportunities

The first step to reducing building energy costs is identifying energy waste. Statistics on utility bills or name plates on equipment, while useful, are not enough to identify what practices and equipment are contributing to high energy use. Portable data loggers can be used to obtain critical energy use information in a wide range of commercial building types – from manufacturing plants to office buildings.

Monitoring HVAC Performance with Data Loggers

Building operators and managers have the difficult job of providing comfortable working conditions and coaxing aging mechanical equipment to operate at peak performance while minimizing energy costs. If the mechanical equipment is old or has inadequate controls, maintaining comfort at a reasonable cost may prove difficult or impossible. Although energy costs typically represent only 1% of a building's operating expense when occupant salaries are included, they are easily managed expenses. Energy cost savings flow directly to the bottom line as increased profits.

The Energy Professional's Guide to Data Loggers & Building Performance

This 30-page guide, developed in conjunction with Stetz Consulting LLC, details how portable data loggers can be applied in a number of building monitoring applications, such as HVAC systems monitoring, commissioning, Measurement & Verification, and load profiling. The guide offers practical tips and techniques on a range of topics, including data logger installation, monitoring plan development, safety, and data interpretation.

Addressing Comfort Complaints With Data Loggers

This paper offers facility managers, HVAC contractors, and others with valuable tips on how low-cost data loggers can be used to validate temperature-related comfort complaints.

Optimizing Solar Thermal Performance with Data loggers

This paper discusses how solar thermal systems, with the help of portable data loggers, can be optimized to deliver the financial benefits residential and commercial users hope to achieve through their investments. The paper shows installers and engineers how portable data logging devices can be used to measure performance of solar thermal systems, pinpoint any defects or inefficiencies, and optimize performance for greater return on investment.

Monitoring Green Roof Performance with Weather Stations

Data logging weather stations are the ideal tools for documenting green roof performance. A weather station can measure weather parameters such as rainfall, stormwater runoff, temperature, relative humidity, wind speed, solar radiation, and a host of non-weather parameters such as soil moisture on a continuous basis (say every five minutes, hourly, or an interval appropriate to the situation). For the purpose of this discussion, "weather station" may refer to a data logger that measures and stores data from weather sensors. The information a weather station collects can help you make wise choices about designing, tuning, and maintaining a green roof.

Measurement & Verification: Tapping into ARRA Stimulus Funds

This paper provides guidance on identifying potential sources of ARRA stimulus funding for energy performance monitoring projects. It details new programs from the ARRA, explains the growing importance of Measurement Verification (M&V) services, and discusses specific ways ESCOs can apply portable data logging technology to document building energy savings.

Using Data Loggers to Meet LEED® Existing Building Certification Credits

This paper provides information about how data loggers can make it simple to satisfy many LEED Existing Buildings Operations & Maintenance credits. It discusses how the devices can help with the certification process and documenting performance improvements for submission to the U.S. Green Building Council.

Monitoring Wetlands with Data Loggers: A Best Practices Guide

Wetlands act as a natural filter for polluted water and thus play an essential role in water quality protection. They serve as floodwater storage to help minimize erosion, and create a habitat for many fish and wildlife.

Access our full resources library at: www.onsetcomp.com/learning

About Onset

Onset is the world's leading supplier of data loggers. Our HOBO data logger products are used around the world in a broad range of monitoring applications, from verifying the performance of green buildings and renewable energy systems to agricultural and coastal research.

Based on Cape Cod, Massachusetts, Onset has sold more than 2 million data loggers since the company's founding in 1981.

Contact Us

Our goal is to make your data logging project a success. Our product application specialists are available to discuss your needs and recommend the right solution for your project.



Sales (8am to 5pm ET, Monday through Friday)

- ▶ Email sales@onsetcomp.com
- ▶ Call 1-800-564-4377
- ▶ Fax 508-759-9100

Technical Support

- ▶ (8am to 8pm ET, Monday through Friday)
- ▶ Contact Product Support
- ▶ Call 877-564-4377

Onset Computer Corporation
470 MacArthur Blvd.
Bourne, MA 02532